



# HEIDENHAIN



**Functional  
Safety**

Product Information

## **ECN 1325 EQN 1337**

Absolute Rotary Encoders  
with Tapered Shaft for  
Safety-Related Applications

09/2019

# ECN 1325, EQN 1337

Rotary encoders for absolute position values with safe singletum information

- Installation diameter 65 mm
- 07B expanding ring coupling
- 65B tapered shaft

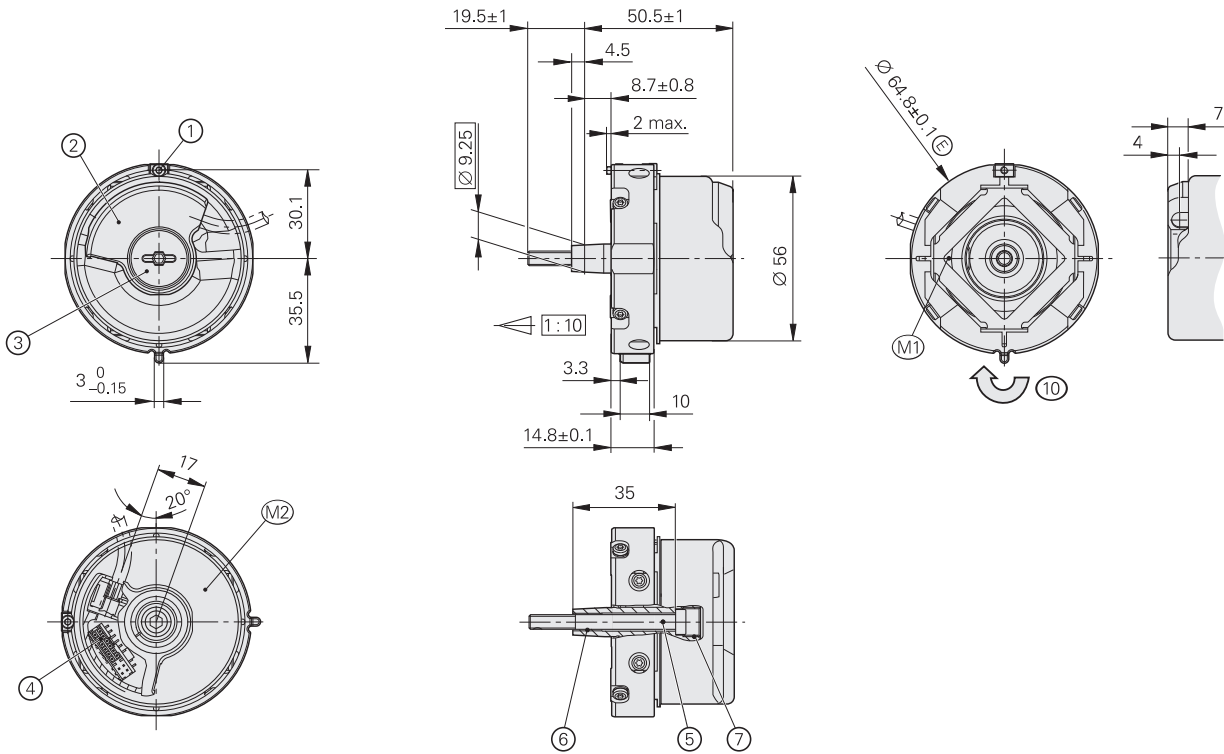

## Required mating dimensions

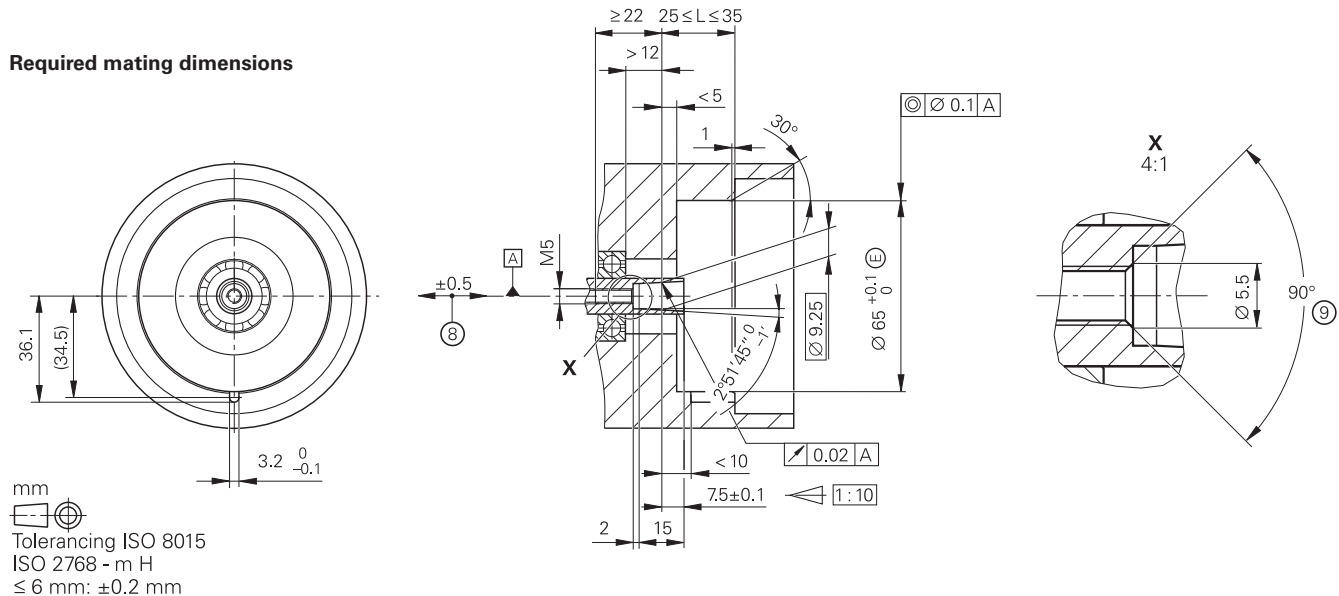

$\boxed{A}$  = Bearing of mating shaft

M1 = Measuring point for operating temperature

M2 = Measuring point for vibration, see D 741714

1 = Clamping screw for coupling ring, width A/F 2, tightening torque: 1.25 Nm -0.2 Nm

2 = Die-cast cover

3 = Screw plug, widths A/F 3 and 4; tightening torque: 5 Nm +0.5 Nm

4 = 16-pin header

5 = Self-locking screw as per DIN 6912 - M5x50, width A/F 4, tightening torque: 5 Nm +0.5 Nm

6 = Back-off thread M6

7 = Back-off thread M10

8 = Compensation of mounting tolerances and thermal expansion, no dynamic motion permitted

9 = Chamfer at start of thread is obligatory for material-bonding anti-rotation lock

10 = Direction of shaft rotation for ascending position values

Specifications	ECN 1325 – singletum	EQN 1337 – multitum
<b>Functional safety</b> for applications up to	As single-encoder system for monitoring functions <ul style="list-style-type: none"> <li>• SIL 1 as per EN 61508 (further basis for testing: EN 61800-5-2)</li> <li>• Category 2, PL c as per EN ISO 13849-1:2015</li> </ul> As single-encoder system for closed-loop functions <ul style="list-style-type: none"> <li>• SIL 2 as per EN 61508 (further basis for testing: EN 61800-5-2)</li> <li>• Category 3, PL d as per EN ISO 13849-1:2015</li> </ul> Safe in the singletum range	
PFH	$\leq 10 \cdot 10^{-9}$ (probability of dangerous failure per hour)	
Safe position <sup>1)</sup>	<i>Encoder</i> : $\pm 1.76^\circ$ (safety-relevant measuring step: SM = 0.7°); <i>mechanical coupling</i> : $\pm 2^\circ$ (fault exclusion for the loosening of the shaft and stator coupling; designed for accelerations of $\leq 300 \text{ m/s}^2$ )	
<b>Interface</b>	EnDat 2.2	
Ordering designation	EnDat22	
Position values per revolution	33 554 432 (25 bits)	
Revolutions	-	4096 (12 bits)
Calculation time $t_{\text{cal}}$ (clock frequency)	$\leq 7 \mu\text{s}$ ( $\leq 8 \text{ MHz}$ )	
<b>System accuracy</b>	$\pm 20''$	
<b>Electrical connection</b>	PCB connector for rotary encoder: 16-pin; with connection for temperature sensor <sup>2)</sup>	
Cable length	$\leq 100 \text{ m}$ (see EnDat description in the <i>Interfaces of HEIDENHAIN Encoders</i> brochure)	
Voltage supply	DC 3.6 V to 14 V	
Power consumption <sup>3)</sup> (max.)	At 3.6 V: $\leq 600 \text{ mW}$ ; at 14 V: $\leq 700 \text{ mW}$	At 3.6 V: $\leq 700 \text{ mW}$ ; at 14 V: $\leq 800 \text{ mW}$
Current consumption (typical)	At 5 V: 85 mA (without load)	At 5 V: 105 mA (without load)
<b>Shaft</b>	65B tapered shaft $\varnothing 9.25 \text{ mm}$ ; taper 1:10	
Shaft speed	$\leq 15\,000 \text{ rpm}$	$\leq 12\,000 \text{ rpm}$
Starting torque at 20 °C	$\leq 0.01 \text{ Nm}$	
Moment of inertia of rotor	$2.6 \cdot 10^{-6} \text{ kgm}^2$	
Angular acceleration of rotor	$\leq 1 \cdot 10^5 \text{ rad/s}^2$	
Natural frequency of the stator coupling (typical)	1800 Hz	
Axial motion of measured shaft	$\leq \pm 0.5 \text{ mm}$	
<b>Vibration</b> 55 Hz to 2000 Hz <b>Shock</b> 6 ms	$\leq 300 \text{ m/s}^2$ <sup>4)</sup> (EN 60068-2-6); 10 Hz to 55 Hz constant over 4.9 mm peak to peak $\leq 2000 \text{ m/s}^2$ (EN 60068-2-27)	
<b>Operating temperature</b>	-40 °C to 115 °C	
<b>Trigger threshold</b> of error message for excessive temperature	125 °C (measuring accuracy of the internal temperature sensor: $\pm 4 \text{ K}$ )	
<b>Relative humidity</b>	$\leq 93 \%$ (40 °C/21 d as per EN 60068-2-78), without condensation	
<b>Protection</b> EN 60529	IP40 (read about <i>Isolation</i> under <i>Electrical safety</i> in the <i>Interfaces of HEIDENHAIN Encoders</i> brochure; contamination from the ingress of fluids must be avoided)	
<b>Mass</b>	$\approx 0.25 \text{ kg}$	
<b>ID number</b>	ID 678919-03/-53 <sup>5)</sup>	ID 678921-03/-53 <sup>5)</sup>

1) Further tolerances may apply in subsequent electronics after position value comparison (contact mfr. of subsequent electronics)

2) See *Temperature measurement in motors* in the *Encoders for Servo Drives* brochure

3) See *General electrical information* in the *Interfaces of HEIDENHAIN Encoders* brochure

4) Valid as per standard at room temp.; at an operating temp. of up to 100 °C:  $\leq 300 \text{ m/s}^2$ ; up to 115 °C:  $\leq 150 \text{ m/s}^2$

5) In collective package upon request

# Mounting

The tapered shaft of the rotary encoder is slid onto the measured shaft and fastened with a central screw. It is particularly important to ensure that the positive-locking element of the stator coupling securely engages the corresponding slot in the measured shaft. Use a screw with material-bonding anti-rotation lock (see *Mounting accessories*). The stator coupling is clamped by an axially tightened screw in a location hole.

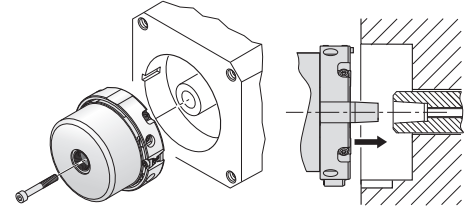

Requirements on the motor side for safe mechanical coupling:

	Mating shaft	Mating stator
Material	Steel	Aluminum
Tensile strength $R_m$	$\geq 600 \text{ N/mm}^2$	$\geq 220 \text{ N/mm}^2$
Interface pressure $P_G$	$\geq 500 \text{ N/mm}^2$	$\geq 200 \text{ N/mm}^2$
Surface roughness $R_z$	$\leq 16 \mu\text{m}$	
Coefficient of thermal expansion $\alpha_{\text{therm}}$	$10 \cdot 10^{-6} \text{ K}^{-1}$ to $17 \cdot 10^{-6} \text{ K}^{-1}$	$\leq 25 \cdot 10^{-6} \text{ K}^{-1}$

For the design of the mechanical fault exclusion for the shaft connection, the following maximum torque  $M_{\text{max}}$  must be considered:

$$M_{\text{max}} = 1.0 \text{ Nm}$$

## Mounting accessories

### Screws

Screws (central screw, mounting screws) are not included in delivery and can be ordered separately.

ECN 1325, EQN 1337	Screws <sup>1)</sup>		Quantity
Central screw for fastening the shaft	DIN 6912- <b>M5</b> ×50-08.8- <b>MKL</b>	ID 202264-54	10 or 100

1) With coating for material-bonding anti-rotation lock

Please note the information on screws from HEIDENHAIN in the *Encoders for Servo Drives* brochure, under *Screws with material bonding anti-rotation lock* in the chapter *General mechanical information*.

### Mounting aid

To avoid damage to the cable, use the mounting aid to connect and disconnect the cable assembly. Apply the pulling force only to the connector and not to the wires.

ID 1075573-01

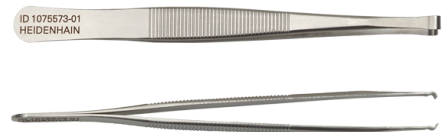





**For further mounting information and mounting aids, please refer to the relevant mounting instructions and the *Encoders for Servo Drives* brochure. The mounting can be tested with the PWM 21 and the ATS software.**

# Electrical connection – Cables

<b>EPG encoder cable inside the motor</b> Ø 3.7 mm (with shield crimping Ø 6.1 mm); [1 × (4 × 0.06 mm <sup>2</sup> ) + 4 × 0.06 mm <sup>2</sup> ] and TPE wires 2 × 0.16 mm <sup>2</sup> for temperature sensor		
With 16-pin PCB connector and 9-pin M23 SpeedTEC angle flange socket (male)		ID 1120948-xx

- 1) **Note for safety-related applications:**
- Document the bit error rate in accordance with Specification 533095!
  - The electromagnetic compatibility of the complete system must be ensured!

SpeedTEC is a registered trademark of TE Connectivity Industrial GmbH

<b>PUR</b> Ø 6 mm; [(4 × 0.14 mm <sup>2</sup> ) + (4 × 0.34 mm <sup>2</sup> ); A <sub>P</sub> = 0.34 mm <sup>2</sup>		8-pin <b>M12 connector</b>	9-pin <b>M23 connector</b>
With 8-pin M12 connector (female) and 8-pin M12 coupling (male) or 9-pin M23 coupling (male)		ID 368330-xx	ID 745796-xx
With 8-pin M12 connector (female) and 15-pin D-sub connector (female)		ID 533627-xx	-
With 8-pin M12 connector (female) and 15-pin D-sub connector (male)		ID 524599-xx	-
With 8-pin M12 connector (female) and free cable end		ID 634265-xx <sup>1)</sup>	-

A<sub>P</sub>: Cross section of power supply lines







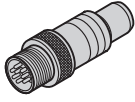
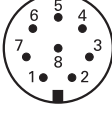

- 1) Connecting element must be suitable for the maximum clock frequency used.

**Note for safety-related applications:**

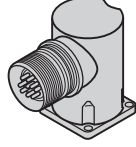
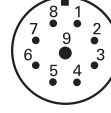
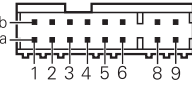
- Document the bit error rate in accordance with Specification 533095!
- The electromagnetic compatibility of the complete system must be ensured!

# Electrical connection

## Pin layout

<b>8-pin M12 coupling or flange socket</b>   		<b>9-pin M23 right-angle socket</b>   								
<b>16-pin PCB connector</b>   16										
	Power supply				Serial data transfer				Other signals <sup>1)</sup>	
 M12	8	2	5	1	3	4	7	6	/	/
 M23	3	7	4	8	5	6	1	2	/	/
 16	1b	6a	4b	3a	6b	1a	2b	5a	8a	8b
	U <sub>p</sub>	Sensor U <sub>p</sub>	0 V	Sensor 0 V	DATA	DATA	CLOCK	CLOCK	T <sup>+</sup> <sup>2)</sup>	T <sup>-</sup> <sup>2)</sup>
	Brown/ Green	Blue	White/ Green	White	Gray	Pink	Violet	Yellow	Brown	Green

1) Only for adapter cables inside the motor housing

2) Connections for external temperature sensor; evaluation optimized for KTY 84-130 (see *Temperature measurement in motors* in the *Encoders for Servo Drives* brochure)

**Cable shield** connected to housing; **Up** = Power supply

**Sensor:** The sense line is connected in the encoder with the corresponding power supply.

Vacant pins and wires must not be used!

**Note for safety-related applications:** Only completely assembled HEIDENHAIN cables are qualified. Do not modify cables or exchange their connectors without first consulting with HEIDENHAIN Traunreut.

SpeedTEC is a registered trademark of TE Connectivity Industrial GmbH

## HEIDENHAIN

**DR. JOHANNES HEIDENHAIN GmbH**

Dr.-Johannes-Heidenhain-Straße 5

83301 Traunreut, Germany

☎ +49 8669 31-0

FAX +49 8669 32-5061

E-mail: info@heidenhain.de

[www.heidenhain.de](http://www.heidenhain.de)

596629 · 07 · C · 02 · 09/2019 · PDF

This Product Information document supersedes all previous editions, which thereby become invalid. The basis for ordering from HEIDENHAIN is always the Product Information document edition valid when the order is made.



**Further information:** Comply with the requirements described in the following documents to ensure the correct and intended operation of the encoder:

- *Encoders for Servo Drives* brochure 208922-xx
- *ECN 1325, EQN 1337* Mounting Instructions 686161-xx
- *Safety-Related Position Measuring Systems* Technical Information 596632-xx
- For implementation in a safe control or inverter: *Specification* 533095-xx
- *Interfaces of HEIDENHAIN Encoders* brochure 1078628-xx
- *Cables and Connectors* brochure 1206103-xx